

The "Convex-Combination Approach," a Geometric Approach to the Optimization of Sailplane Trajectories

J.L. de Jong

University of Technology, Eindhoven

(The following is an abridged version of Eindhoven Technical University paper COSOR 80-10. It covers an update of material presented at the XVI OSTIV Congress, Chateauroux, France (1978) and new material presented at the XVII OSTIV Congress, Paderborn, Germany, 1981.

SUMMARY

Three different problems encountered in the sport of soaring are discussed: First, as an introduction, the classical "MacCready problem" is reviewed; this is concerned with the determination of the best cruise speed between columns of rising air under cumulus clouds. Next, a new solution concept is presented for the "optimal dolphin soaring problem." This is the problem of determining the best (varying) speed through regions with varying vertical atmospheric velocities. Finally, some new ideas are discussed which make new solutions possible to the "optimal zigzagging problem," which is the problem of whether, and if so how, to make use of favorable regions with upward atmospheric velocities which are present aside of the track to be flown.

List of Symbols

L : length of range
h : height
t : time
u : vertical velocity of atmosphere
v : (horizontal) velocity of the sailplane
w : vertical velocity of the sailplane
x : coordinate in horizontal direction
z : absolute rate of climb, MacCready ring setting
 β : fly-off angle (in horizontal plane)
 γ : flight path angle (in vertical plane)
 ϕ : course direction (in the horizontal plane)
 \underline{r} : vector

Subscripts

A,B,C,... : points on trajectory
AB,BC,... : trajectory part from A to B, B to A,...
ABC,... : broken trajectory from A via B to C

AB/C,... : related to trajectory part AB relative to value at C
BSF : best-straight-flight
Mcr : MacCready problem solution
ZAV : zero-average-velocity
ZL : zero (altitude) loss
a : atmosphere
av : average
cl : climb
cr : cruise
max : maximum
min : minimum
mind : minimum descent
mr : maximum over range
opt : optimum
orv : optimal range velocity
p : polar
r : resulting
th : thermal

1. INTRODUCTION

The determination of the instantaneous horizontal velocity which yields the highest average velocity along the course, taking into account the time spent gaining altitude, is the fundamental optimization problem in soaring. The three main variants of this problem are: 1. the MacCready problem, 2. the dolphin soaring problem, and 3. the zig-zagging problem. In this paper attention is paid to all three problems but the first is discussed mainly for the sake of its central role in the theory.

2. The MacCready Problem, the MacCready Ring and the Sollfahrtgeber.

2.1 The MacCready problem.

In any discussion about sailplane trajectory optimization, two concepts play a central role: thermals and the velocity polar. We take "thermal" to mean a column of rising air large enough for a sailplane to circle in, and assume that the vertical velocity of the air is constant. This implies that the (absolute) rate of climb of the sailplane is also constant. The term "velocity polar" means the relationship (equilibrium) velocities of the sailplane (see Fig. 2). The velocity polar

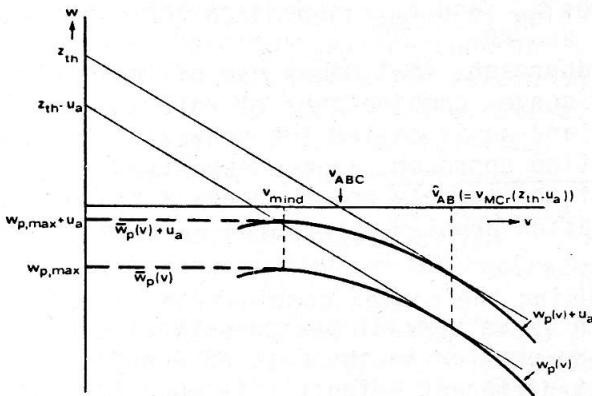

Fig. 2: The standard and the absolute (regular and extended) velocity polar

depends on the sailplane's weight and the air density; these are usually considered invariable. The relationship

is represented by

$$(2.1) \quad w = w_p(v)$$

where w is the vertical velocity of the sailplane relative to the air and v is its horizontal velocity. The difference between the horizontal and total velocities may normally be neglected.

The basic problem in sailplane trajectory optimization is the MacCready problem. This is the question as to how fast the sailplane should fly between thermals in order to minimize the flight time from point A (see Fig. 1) in one

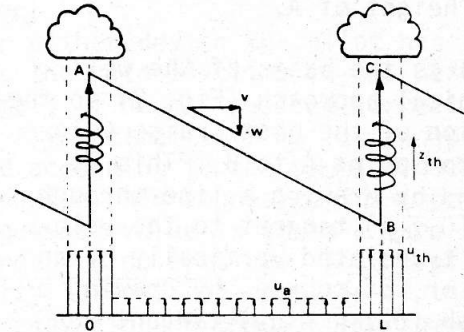

Fig. 1: The classical MacCready problem

thermal to point C at the same height in the next. If the horizontal distance between the two thermals is L , the absolute rate of climb in the next thermal is z_{th} and the atmosphere between the thermals has a constant vertical velocity u_a , the MacCready problem reads

$$(2.2) \quad \min \left\{ \frac{L}{v} + \frac{\Delta h}{z_{th}} \left| \Delta h + \frac{L}{v} [w_p(v) + u_a] \right. \right. \\ \left. \left. = 0, \Delta h \geq 0, v_{min} \leq v \leq v_{max} \right\}$$

The inequalities for h and v are commonly not explicitly stated. When, as usual, it is assumed that they are strictly satisfied, the problem reduces to the minimization of the time t_{ABC} given by

$$(2.3) \quad t_{ABC} = \frac{L}{v} \left[\frac{z_{th} - (w_p(v) + u_a)}{z_{th}} \right]$$

By differentiation with respect to v it can be shown that

$$(2.4) \quad -\frac{dw_p}{dv}(v) = \frac{z_{th} - (w_p(v) + u_a)}{v}$$

This is the MacCready relation. It plays a central role in the theory and the implementation of optimal flight trajectories. A few remarks may be made:

(i) The absence of L in the expression implies that the optimal solution is independent of distance. In practice, it does play a role since it affects the altitude loss which of course should not exceed the height of A .

(ii) (2.4) is the basis of the well known graphical approach (Fig. 2) to the determination of the best cruise velocity v_{AB} from point A to B . This is easily found by drawing a line through the point $(0, z_{th})$ tangent to the velocity polar translated vertically by an amount u_a , or, of course, by drawing a line through $(0, z_{th} - u_a)$ tangent to the velocity polar itself.

(iii) The average velocity v_{ABC} from A via B to C is given by the intersection of the tangent line with the horizontal axis, and is equal to

$$(2.5) \quad v_{ABC} = \frac{L}{t_{ABC}} = \frac{z_{th}}{z_{th} - (w_p(v) + u_a)} v$$

(iv) The optimal average velocity when u_a is zero depends on z_{th} in the next thermal (for $z_{th} \geq 0$). It is usually called the MacCready travel velocity and is denoted by

$$(2.6) \quad v_{MC,r}(z_{th}) = \frac{z_{th}}{z_{th} - w_p(v_{MC,r}(z_{th}))} v_{MC,r}(z_{th})$$

(v) When u_a is not constant but varies with the distance coordinate x ($C \leq x \leq !$), the MacCready relation becomes

$$(2.7) \quad -v(x) \frac{dw_p}{dv}(v(x)) + w_p(v(x)) + u_a(x) = z_{th}$$

(vi) Considering the MacCready problem to be one of maximizing v_{ABC} , two related very simple geometric properties hold as follows:

Convex Combination Property I: Let ABC be a broken trajectory (Fig. 3) and let

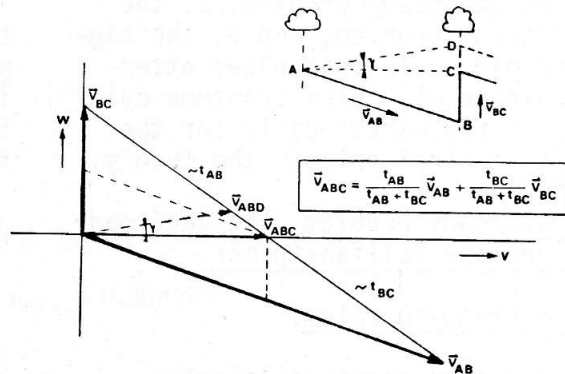

Fig. 3: The convex combination properties

\vec{v}_{AB} and \vec{v}_{BC} be the velocity vectors in the directions AB and BC respectively. Then the resulting velocity \vec{v}_{ABC} in the direction AC is equal to the convex combination in the direction AC of those velocity vectors.

Convex Combination Property II: The line that connects the end points of \vec{v}_{AB} and \vec{v}_{BC} (Fig. 3) is divided by the endpoint of \vec{v}_{ABC} into two pieces, the lengths of which are proportional to the times t_{BC} and t_{AB} , spent on the legs BC and AB .

This approach, that makes use of the idea of convex combinations of velocities, and so is called the convex combination approach, is the essential basis of the largely novel approach to optimization problems presented here.

(vii) Using the convex combinations approach it is very simple to solve the MacCready problem in the case of A and C being at different heights. In most cases, the same v_{AB} will be optimal, but the time to climb in the thermal will vary with the height of C (Fig.3).

(viii) Horizontal wind velocities are assumed not to influence the optimal solution to the MacCready problem on the

basis that the horizontal wind is constant for the whole flight. The pilot who flies the fastest relative to the air will also be fastest in the absolute sense. Similar considerations will hold with respect to the other two problems.

2. The MacCready Ring and the Sollfahrtgeber

Two analogous devices have been developed for giving the pilot a visual indication of how well the MacCready relation is satisfied, by indicating how to choose his (horizontal) speed.

A MacCready Ring is a movable ring mounted around a rate-of-climb indicator with a linear scale (Fig. 4). On the

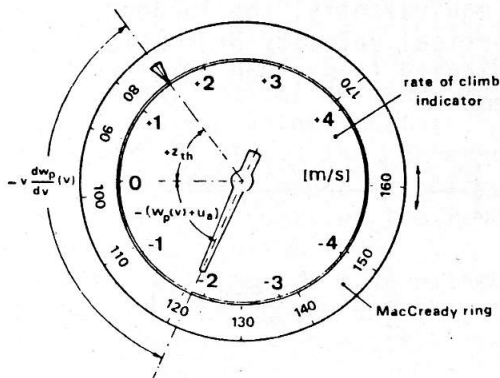

Fig. 4: MacCready ring around rate of climb indicator

ring one reference mark is engraved, and other marks which correspond to velocities to be flown, as sketched in Fig. 4. The pilot sets the reference mark against the scale of the rate-of-climb indicator at the anticipated rate-of-climb in the next thermal. Thereafter, he flies at the velocity towards which the rate-of-climb indicator is pointing on the MacCready ring.

The disadvantage of the MacCready ring is that one has to compare at any moment the actual velocity with that indicated by the pointer of the rate-of-climb indicator at the ring. This implies reading two instruments simultaneously - always more difficult than reading only one. Hence, the development of the "Sollfahrtgeber" or "speed director," in essence a modified rate-of-climb

indicator, with the quantity $-v(x) \frac{dw_p(v(x))}{dv} + u_a(x) + w_p(v(x))$.

It does this by superimposing on the signal for the absolute rate-of-climb another signal proportional to the equivalent vertical velocity $-v(x) \frac{dw_p(v(x))}{dv}$, either mechanically or

electronically. The pilot has only to take care that the pointer of the Sollfahrtgeber points towards the expected rate-of-climb in the next thermal. If it points to a higher value the pilot should fly more slowly; if towards a lower value, he should fly faster.

For either device the pilot has to guess the rate-of-climb in the next thermal; if he has guessed correctly he will fly optimally if he just adapts his speed according to the command given by the device. To emphasize its importance the guessed value is given a name - the MacCready ring setting. If the pilot exactly follows the commands of the MacCready ring or the Sollfahrtgeber, the optimality will only depend on the proper value of the MacCready ring setting.

3. The generalized dolphin soaring problem and the optimal range velocity polar

3.1 The generalized dolphin soaring problem

If the vertical atmospheric velocity varies over the range, the optimal strategy will in general be to fly fast through down drafts and slow through up drafts. The resulting trajectory shows some resemblance to that of a jumping dolphin and accordingly is called (quasi-stationary) dolphin soaring (Fig. 5).

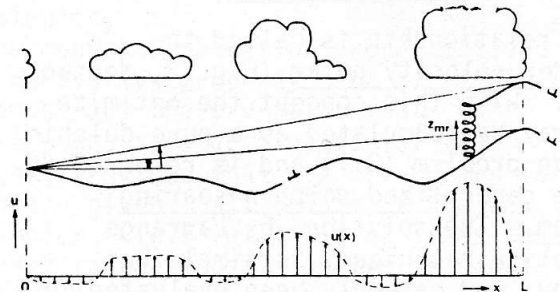

Fig. 5: The (generalized) dolphin soaring problem

Where cloudstreets cover part of the trajectory, proper use of the MacCready ring or the Sollfahrtgeber results in an altitude gain instead of a loss. In that case no circling in the next thermal is necessary and the pilot can fly faster and increase the average velocity. A new problem may be formulated: "When the vertical atmosphere velocity varies, how to select the instantaneous horizontal velocity such that the average horizontal velocity is maximized for a prescribed altitude gain (or loss)." In mathematical terms, this leads to the constrained minimization problem

$$(3.1) \min_{v(x)} \left\{ \int_0^L \frac{dx}{v(x)} \mid \int_0^L \frac{w_p(v(x)) + u_a(x)}{v(x)} dx = L \tan \gamma \right\}$$

This is known as the pure dolphin soaring problem. The general optimization problem may be formulated as (cf.(2.2))

$$(3.2) \min_{v(x)} \left\{ \int_0^L \frac{dx}{v(x)} + \sum_i \frac{\Delta h_i}{z_{th,i}} \mid \sum_i \Delta h_i + \int_0^L \frac{w_p(v(x)) + u_a(x)}{v(x)} dx = L \tan \gamma \mid \Delta h_i \geq 0, v_{min} \leq v \leq v_{max} \right\}.$$

(3.2) differs from (3.1) only through the assumed presence of isolated thermals. Alternatively, one can assume for the sake of modelling that circling is replaced by a straight climb over the width of the thermal and that w_p is constant for velocities below v_{mind} , so that

$$(3.3) \quad \bar{w}_p(v) := w_p(v_{mind}) \quad \text{for } v \leq v_{mind} \\ := w_p(v) \quad \text{" } v \geq v_{mind}$$

The relationship is called the extended velocity polar (Fig. 2, dotted line). With this concept the optimization may be formulated as a pure dolphin soaring problem (3.1) and is referred to as the generalized dolphin soaring problem. The solution, by Lagrange multiplier technique, is simple but lengthy, and has only been evaluated for

some special cases such as the sinusoidal distribution (Ref. K-1) and the square-wave distribution (Ref. M-1). The results however serve as a guide for the MacCready ring setting in many practical cases.

3.2 The optimal-range-velocity polar or orv-polar

Given any range (0,L) and any vertical atmospheric velocity distribution, there will in general be an infinite number of horizontal velocity histories $v(x)$ that yield the same average horizontal velocity v_{av} . This will be true for small v_{av} if one allows circling or flying S-curves. The velocity histories of most interest are those that result in the smallest altitude loss or largest gain, or, equivalently, the largest average vertical velocity or smallest descent velocity (i.e., the solution of the problem)

$$(3.4) \quad \max \left\{ \frac{v_{av}}{L} \int_0^L \frac{\bar{w}_p(v(x)) + u_a(x)}{v(x)} dx \mid \frac{v_{av}}{L} \int_0^L \frac{dx}{v(x)} = 1 \right\}$$

This problem is of the same type as the generalized dolphin soaring problem (3.1), and its solution may accordingly be determined with the same technique. For the present problem the optimal velocity history $v(x)$ satisfies the relation

$$(3.5) \quad -v(x) \frac{d\bar{w}_p}{dv}(v(x)) + \bar{w}_p(v(x)) + u_a(x) = z(v_{av})$$

where $z(v_{av})$ is the Lagrange multiplier which will in general vary with v_{av} . The bar over w_p signifies the use of the extended-velocity-polar relationship (3.3). The actual value of $z(v_{av})$ is to be determined from

$$(3.6) \quad \frac{v_{av}}{L} \int_0^L \frac{dx}{v(x)} = 1$$

The solution of (3.4) i.e., the maximal average vertical velocity for given

average horizontal velocity will play such an important role in the development to follow that it is given the special name optimal vertical range velocity w_{orv} . It may be determined for any value of v_{av} . The formal relation between the two is

$$(3.7) \quad w_{orv}(v_{av}) := \max \left\{ \frac{v_{av}}{L} \int_0^L \frac{\bar{w}_p(v(x)) + u_a(x)}{v(x)} dx \right. \\ \left. \left| \frac{v_{av}}{L} \int_0^L \frac{dx}{v(x)} = 1 \right. \right\}$$

This relationship, which may be plotted (Fig. 6) in a way similar to the extended velocity polar, is called the optimal-range-velocity-polar or orv-polar (for the given range and vertical atmospheric velocity distribution).

The orv-polar yields the result of the use of an optimal strategy for given v_{av} . Since any optimal strategy must result in some v_{av} value, that strategy must result in the corresponding optimal vertical range velocity. The orv-polar thus contains the results of all possible minimum time strategies. This makes it an extremely useful tool in the theory and the practice of soaring strategies.

3.3 Geometric construction of orv-polars

Intimately related to any point of the orv-polar is the value of the Lagrange multiplier $z(v_{av})$. From (3.7) the derivative of the orv-polar satisfies the relationship

$$(3.8) \quad \frac{dw_{orv}}{dv_{av}}(v_{av}) = - \frac{z(v_{av}) - w_{orv}(v_{av})}{v_{av}} \quad (v_{av} > 0)$$

The proof of this is not included here. It is of more interest to note that the derivative property implies a similar relationship (for the orv-polar) and the MacCready relation (2.7). The optimal MacCready ring setting follows from the geometrically interpretable expression (Fig. 6).

$$(3.9) \quad -v_{av} \frac{dw_{orv}}{dv_{av}}(v_{av}) + w_{orv}(v_{av}) = z(v_{av})$$

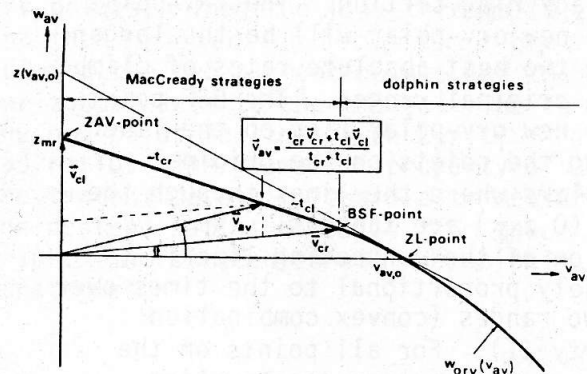

Fig. 6: The orv-polar for the range and atmospheric vertical velocity distribution of Fig. 5

Two points on any orv-polar are of most interest. The first is the zero-average-velocity point or ZAV-point. This lies on the vertical axis and corresponds to the best absolute rate-of-climb z_{mr} ($mr = \text{maximum range}$) that can be realized at some point of the range. The second is the best-straight-flight or BSF-point which corresponds to a MacCready setting z_{BSF} equal to z_{mr} . With the convex combination property I it is easy to show that all points of the orv-polar that correspond to v_{av} smaller than $v_{av,BSF}$ lie on the straight line connecting the ZAV-point and the BSF-point. The corresponding optimal strategy is called a MacCready strategy and consists of climbing at the point where z_{mr} can be realized, followed (or preceded) by a straight flight with that as MacCready ring setting.

A direct consequence of (3.8) and the concavity of the orv-polar is that for v_{av} larger than $v_{av,BSF}$ the MacCready ring setting will be larger. In this case one should fly straight and follow the commands of the MacCready ring or the Sollfahrtgeber. This is called dolphin strategy. The BSF-point is the transition point for the two strategies.

The convex combination property I and the derivative property make it simple to construct the orv-polar that corresponds to a combination of two ranges, provided that the orv-polars for each are given. All points of the new orv-polar (Fig.7) will lie on lines that connect tangent points on the original orv-polars corresponding to the same

MacCready ring setting. The ZAV-point of the new orv-polar will be the larger of the two best absolute rates of climb on the original ranges. The BSF-point of the new orv-polar lies on the line joining the points on the original orv-polars where the lines through the point $(0, z_{mr})$ are tangent. The division of the connecting line is inversely proportional to the times over the two ranges (convex combination property II). For all points on the concave part the same construction applies.

Even more useful is the rule (Fig. 7)

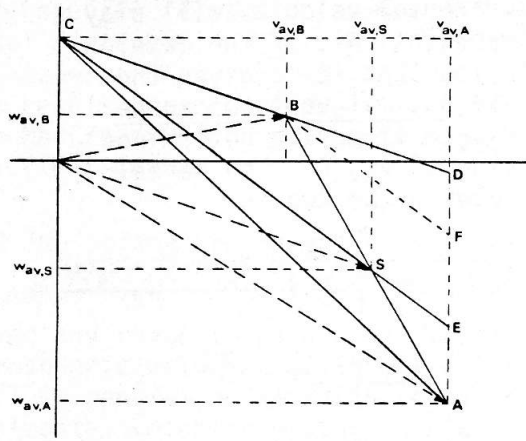

Fig. 8: Proof of the geometric property of the tangent lines of orv-polars

An example of the fruitful use of this geometric property of the tangent lines is given in the next paragraph.

3.4 A practical application: The orv-polar and the optimal strategy for cloudstreet flying

In the real world a pilot will never know the exact vertical atmospheric velocity he will encounter along his course line. Therefore, the best that one can do is to provide him with guidelines based on simple models and leave him to interpret the real situation in the light of those solutions.

A model of much interest is the general square wave vertical atmospheric velocity model, as advocated by Reichmann (R-1) and illustrated in Fig. 9. The range consists of two parts of length L_1 and L_2 having constant vertical atmospheric velocities u_1 and u_2 where $u_1 \leq u_2$.

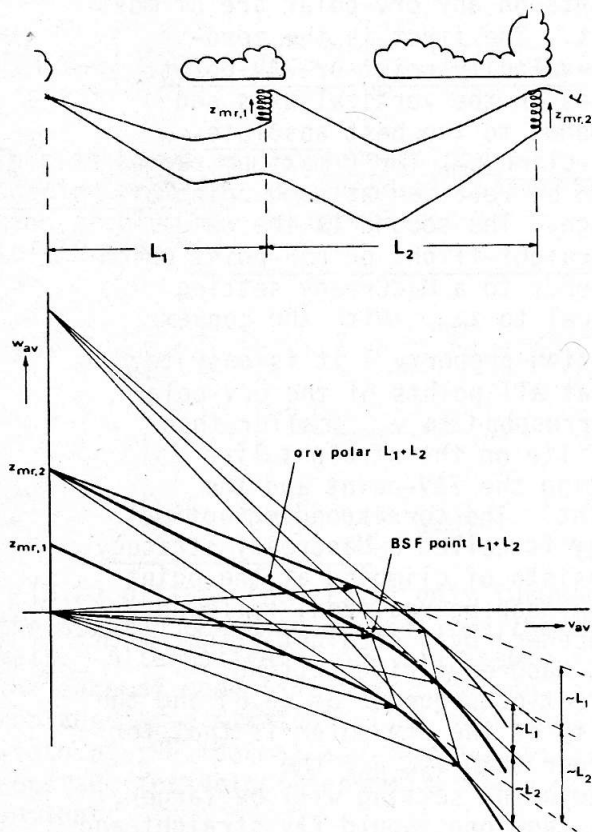

Fig. 7: Construction of an orv-polar by synthesis of two known orv-polars

that any vertical line is cut by the three tangent lines (the middle one being tangent to the new ore-polar) into pieces that are inversely proportional to the length of the two ranges. This follows from some simple geometry (Fig. 8)

$$(3.10) \quad \frac{AE}{ED} = \frac{AE}{EF} \cdot \frac{EF}{ED} = \frac{AS}{SB} \cdot \frac{v_{av,B}}{v_{av,A}} = \frac{t_2}{t_1} \cdot \frac{v_{av,2}}{v_{av,1}} = \frac{L_2}{L_1}$$

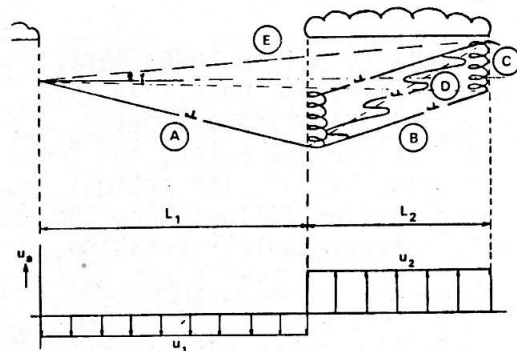

Fig. 9: The (generalized) dolphin soaring problem square wave atmospheric model

Of much interest for practical application are plots of the MacCready ring settings for different ratios L_2/L_1 or, better, of $L_2/(L_1 + L_2)$, which result in optimal trajectories with no overall height change (Fig. 10). To

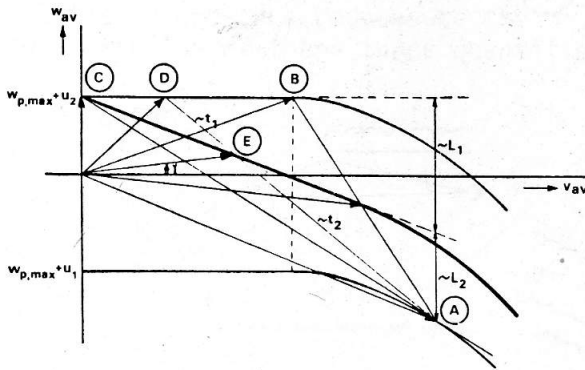

Fig. 10: The orv-polar for the atmospheric model of Fig. 9

construct such a plot for a particular combination of u_1 and u_2 , first evaluate the "break point," i.e., the first ratio $L_2/(L_1 + L_2)$ for which a MacCready ring setting equal to z_{mr} just results in a straight flight with no overall height change. This ratio can be determined geometrically (Fig. 11a). The line joining the two tangent points on lines through the point $(0, z_{mr})$ is drawn. The intersection point of this line with the horizontal axis is the BSF-point of the orv-polar that applies to the break point ratio. The latter can thereafter be determined as the ratio of the line lengths cut off from an arbitrary vertical line by the two tangent lines through $(0, z_{mr})$ and the newly found BSF-point.

For all ratios $L_2/(L_1 + L_2)$ smaller than the break point ratio, the best MacCready ring setting will be the best z_{mr} and the strategy will be MacCready. The corresponding part of the plot is accordingly just a horizontal line. For larger ratios interpolation may be made between points (Fig. 11b) which correspond to distinct values of the ring settings. The ratio that corresponds to a fixed ring setting z may be determined similarly. Tangent lines through the point $(0, z)$ are drawn to the two original

orv-polars. Then the line through $(0, z)$ and the intersection between the line joining the two tangent points and the horizontal axis is the tangent line to the orv-polar for the given $L_2/(L_1 + L_2)$ ratio. The geometric property of the tangent makes it feasible to measure the desired ratios directly from the graph. The strategies will be dolphin strategies.

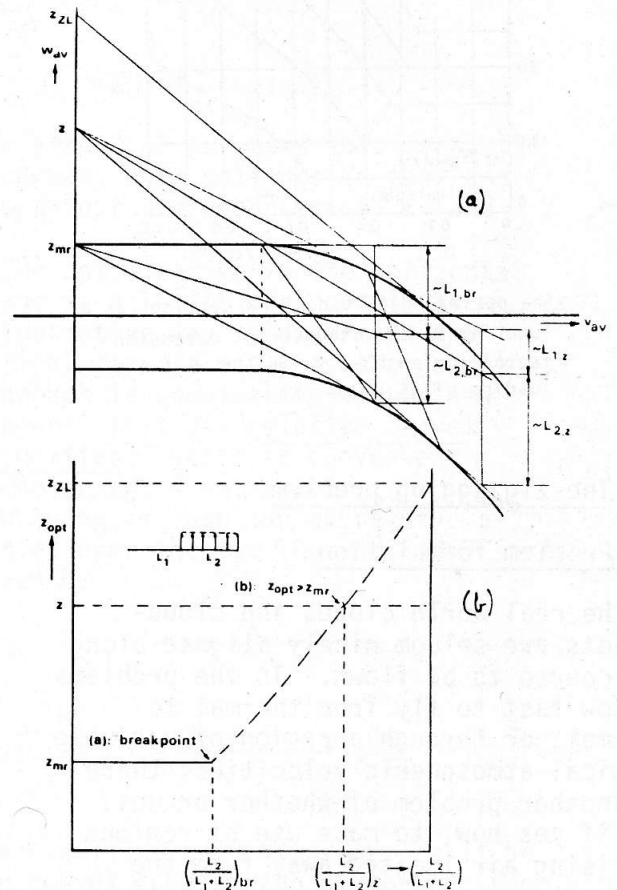

Fig. 11: Graphical construction of a plot of optimal MacCready ring settings as a function of the cloudstreet extension ratio $L_2/(L_1 + L_2)$

An example is given in Fig. 12. It should be remarked that the orv-polar concept makes it possible for any sailplane pilot to construct plots like these with no more aids than a velocity polar, a ruler and a pencil.

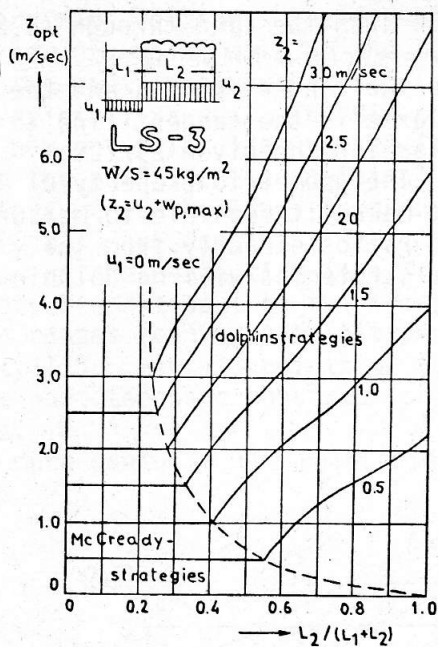

Fig. 12: The optimal MacCready ring settings as a function of the cloudstreet extension factor for an LS-3 sailplane with a wing loading of 45 kb/m²

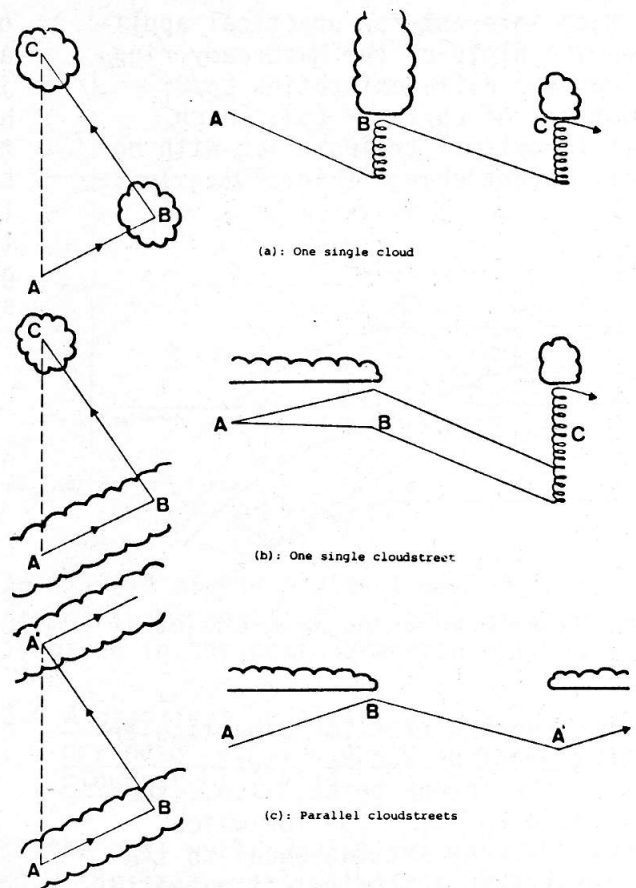

Fig. 13: The three main variants of the zigzagging problem

4. The zigzagging problem

4.1 Problem formulation

In the real world clouds and cloudstreets are seldom nicely aligned along the course to be flown. To the problems of how fast to fly from thermal to thermal, or through a region of variable vertical atmospheric velocities, there is another problem of whether or not, and if yes how, to make use of regions of rising air located away from the track or running at an angle to it. This problem is called the "optimal zigzagging problem." There are three main variants (Fig. 13): (i) one single cloud at some distance from the track, (ii) one simple cloudstreet and, (iii) a system of parallel cloudstreets.

The criterion for the decision whether or not to make a detour is the time to fly from the starting point A to the point C (at the same height above the track) or, in other words, the comparison between the resulting velocities from A to C with and without the detour, i.e. $v_{ABC,r}$ and $v_{AC,r}$, respectively.

The determination of the best achievable resulting velocity $v_{ABC,r}$ in the case of a detour is somewhat more complicated than that for no detour as it involves simultaneous optimization in both the horizontal and the vertical planes. The optimization in the horizontal plane usually concerns the location of either the point C (when the location of point B is given (variant (i)) or the point B (when the location of point C is given (variant (ii) and (iii))). The location of either of these points is geometrically determined by the fly-off-angle β which is the angle between the two consecutive legs AB and BC of the detour (Fig. 14). The optimization in the horizontal plane thus reduces to the determination of the optimal fly-off angle. The optimization in the vertical plane concerns all three variants that are similar to those for MacCready and dolphin flying. A complicating factor is the

usual limitation on the height h_B of B relative to that of A and C; the optimal strategy turns out to be fully determined by h_B and by the two cruise velocities $v_{AB,cr}$ and $v_{BC,cr}$ (or, equivalently, the two MacCready ring settings). The optimization in the vertical plane thus reduces to the determination of these three quantities.

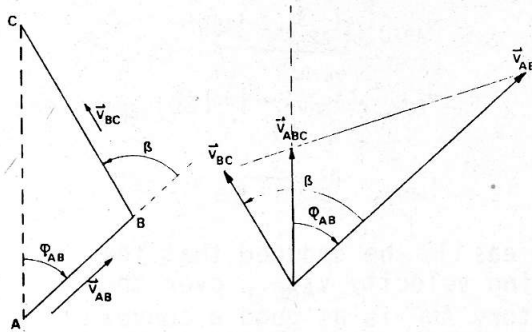

Fig. 14: The resulting velocity v_{ABC} over the broken trajectory A-B-C and the fly-off angle β

Assuming constant vertical atmospheric velocities, the general optimal zig-zagging problem may be phrased as follows: Given the (course) direction ϕ_{AB} of the possible first leg AB of the detour, the precise location of either B or C, the strength of the vertical atmospheric velocities u_{AB} and u_{BC} , the best absolute rates of climb z_B at B and z_C at C, and finally the maximum height difference $h_{B,max}$ at point B, then determine the optimal fly-off angle β , the optimal cruise velocities $v_{AB,cr}$ and $v_{BC,cr}$ and the optimal height of B that together result in the highest resulting or travel velocity $v_{ABC,r}$ and so the shortest time to fly from A to C.

4.2 The single cloud problem and the concept of relative travel velocities

For the single cloud problem (Fig. 15) the theory of the MacCready problem is directly applicable. In particular, there are two optimal cruise velocities, which satisfy the appropriate MacCready relations

$$(4.1) \quad -v_{AB,cr} \frac{dw}{dv} (v_{AB,cr}) + w_p(v_{AB,cr}) + u_{AB} = z_B$$

$$(4.2) \quad -v_{BC,cr} \frac{dw}{dv} (v_{BC,cr}) + w_p(v_{BC,cr}) + u_{BC} = z_C$$

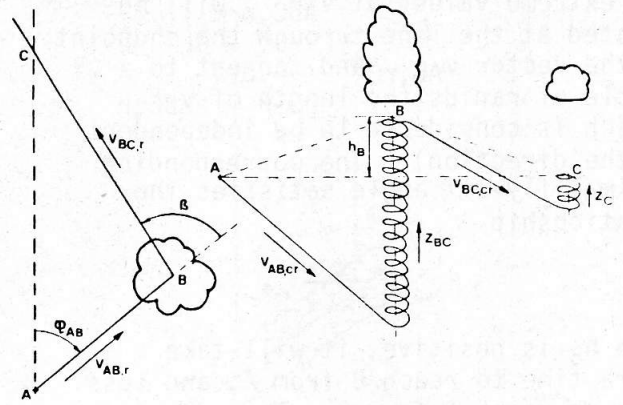

Fig. 15: The single cloud problem

For practical purposes this means the MacCready ring settings on the legs of the detour are respectively z_B and z_C .

The optimization in the horizontal plane is a little more complicated. An illustrative way to determine the optimal fly-off angle is the geometric approach in combination with a new concept, that of "relative travel velocities," which is convenient whenever h_B is not zero.

When h_B is zero the average velocities over the two legs AB and BC are given by

$$(4.3) \quad v_{AB,r} = \frac{z_B}{z_B - w_p(v_{AB,cr})} v_{AB,cr} = v_{MCr,r}(z_B)$$

$$(4.4) \quad v_{BC,r} = \frac{z_C}{z_C - w_p(v_{BC,cr})} v_{BC,cr} = v_{MCr,r}(z_C)$$

The resulting velocity $v_{ABC,r}$ will be the convex combination of these. From geometry (Fig. 16) it will be immediately clear that, with B being variable,

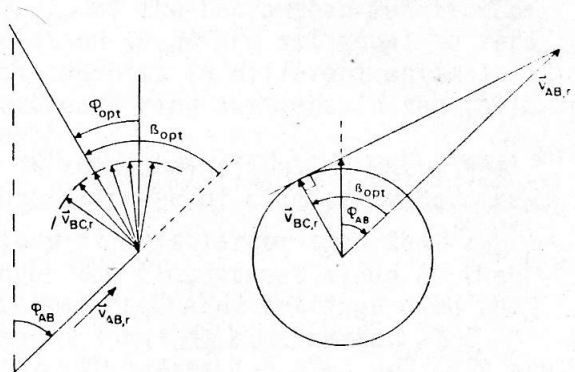

Fig. 16: Geometric construction of the optimal fly-off angle

the extreme values of $v_{ABC,r}$ will be located at the line through the endpoint of the vector $v_{AB,r}$ and tangent to a circle of radius the length of $v_{BC,r}$ (which is considered to be independent of the direction). The corresponding optimal fly-off angle satisfies the relationship

$$(4.5) \quad \cos \beta_{opt} = \frac{v_{BC,r}}{v_{AB,r}}$$

When h_B is positive, it will take extra time to reach B from A, and less time to reach C from B. The average velocity $v_{AB,av}$ from A to B will decrease and the average velocity $v_{BC,av}$ from B to C will increase. Yet, it will be clear, that it is only advantageous to climb higher at B as the absolute rate of climb there is higher than at C. The gain in time is then realized over AB and not over BC, in contrast to what the average velocities would indicate. The concept of relative travel velocities is now introduced to remedy this discrepancy. To that end the relative velocity $v_{AB/C}$ over the leg AB relative to the absolute rate of climb at C is defined as the length of AB divided by the relative time $t_{AB/C}$ which is the real time minus the time gain (Fig. 17)

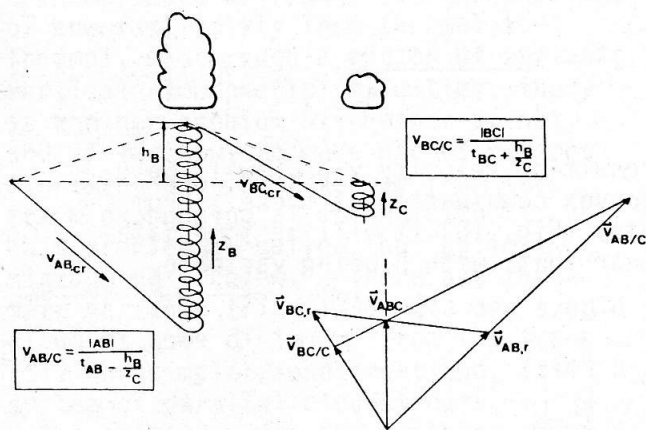

Fig. 17: The concept of relative travel velocities and the construction of the resulting velocity over a broken trajectory

$$(4.6) \quad v_{AB/C} = \frac{|AB|}{t_{AB} - \left(\frac{h_B}{z_C}\right)} = \frac{|AB|}{t_{AB/C}}$$

Similarly, the relative travel velocity $v_{BC/C}$ over the leg BC relative to the absolute rate of climb at C is defined as

$$(4.7) \quad v_{BC/C} = \frac{|BC|}{t_{BC} + \left(\frac{h_B}{z_C}\right)} = \frac{|BC|}{t_{BC/C}}$$

Since obviously

$$v_{AB/C} \cdot t_{AB/C} = |AB|$$

$$v_{BC/C} \cdot t_{BC/C} = |BC|$$

and

$$t_{AB/C} + t_{BC/C} = t_{AB} + t_{BC}$$

it may easily be deduced that the resulting velocity $v_{ABC,r}$ over the trajectory ABC is as good a convex combination of the relative travel velocities $v_{AB/C}$ and $v_{BC/C}$ as of the real average velocities $v_{AB,av}$ and $v_{BC,av}$ since

$$(4.8) \quad v_{ABC,r} = \frac{t_{AB/C} v_{AB/C} + t_{BC/C} v_{BC/C}}{t_{AB/C} + t_{BC/C}}$$

The optimal fly-off angle in case of non zero h_B is analogously given by

$$(4.9) \quad \cos \beta_{opt} = \frac{v_{BC/C}}{v_{AB/C}}$$

Since the resulting velocities $v_{AB,r}$ and $v_{BC/C}$ are equal to the relative velocities $v_{AB/C}$ and $v_{BC/C}$ as long as h_B is zero, it follows directly that relation (4.9) for the optimal fly-off angle contains relation (4.8) as a special case. Relation (4.9) may therefore be considered as the general expression for the optimal fly-off angle.

It should be mentioned that the relative velocities can also be determined graphically as sketched in Fig. 18, which shows the orv-polar over the range AB. The optimal average horizontal and vertical velocities may be determined by intersecting the orv-polar with a line under an angle equal to the flight path angle

$$(4.10) \quad \gamma_{AB} = \arctan \frac{h_B}{AB}, \quad \gamma_{BC} = -\arctan \frac{h_B}{BC}$$

With

$$(4.11) \quad v_{AB \text{ av}} = \frac{|AB|}{t_{AB}}, \quad w_{AB \text{ av}} = \frac{h_B}{t_{AB}}$$

$$v_{BC \text{ av}} = \frac{|BC|}{t_{BC}}, \quad w_{BC \text{ av}} = -\frac{h_B}{t_{BC}}$$

it may readily be deduced that the relative velocity on the range AB is also given by the expression

$$(4.12) \quad v_{AB/C} = \frac{z_C}{z_C - w_{AB \text{ av}}} v_{AB \text{ av}}$$

and, analogously,

$$(4.13) \quad v_{BC/C} = \frac{z_C}{z_C - w_{BC \text{ av}}} v_{BC \text{ av}}$$

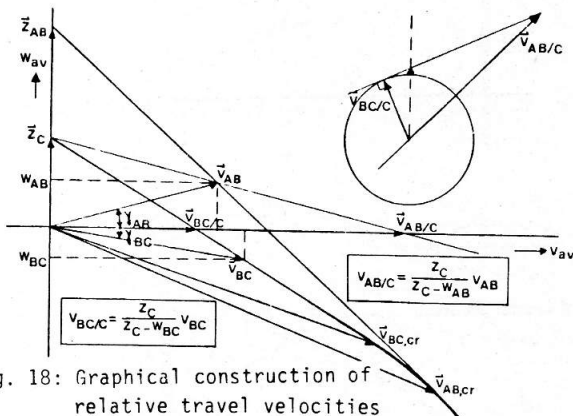

Fig. 18: Graphical construction of relative travel velocities

4.3 The single cloudstreet problem

For this problem it is assumed that the location of C in the horizontal plane (Fig. 19a) is given and that the location of B, where the pilot should leave the cloudstreet, is to be determined. This determination again requires a simultaneous optimization in the horizontal and vertical planes (Fig. 19b). However in a number of not uncommon situations this cannot be decoupled into two independent vertical and horizontal plane optimizations.

A complication is caused by the fact that the location of B on the range in the vertical plane or, equivalently, the relative length of the cloudstreet part of the range, is to be determined as a result of the optimization in the horizontal plane and therefore the knowledge of the average velocities on

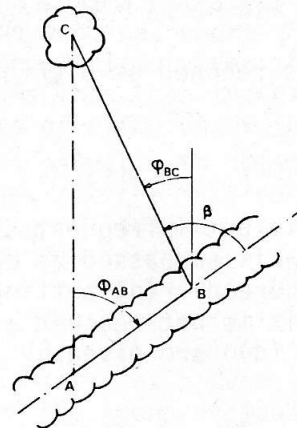

Fig. 19a: The single cloudstreet problem in the horizontal plane

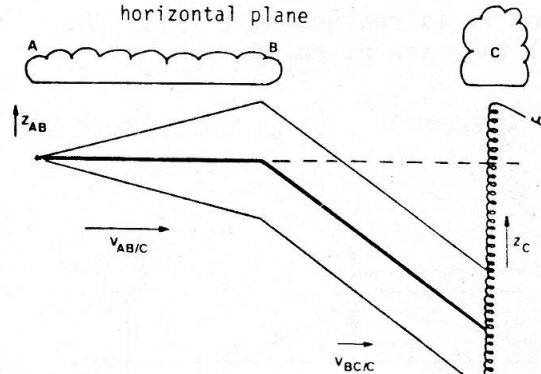

Fig. 19b: The single cloudstreet problem in the vertical plane

the legs AB and BC is required. In the usual practical situation where the maximum height is reached at B (Fig. 20, cases (d) and (e)) these average velocities depend on the location of the B. A straightforward iterative procedure is unfortunately almost prohibitive for most practical situations. However, the main conditions for optimality in the vertical plane follow when the derivatives with respect to $v_{AB,cr}$ and $v_{BC,cr}$ of the Lagrangean function of relation (4.2) are set equal to zero. This results in different optimal MacCready ring settings in the following way:

In the usual situation where the absolute rate of climb z_C under the cloud at C is larger than that z_{AB} under the cloudstreet along AB, the optimal MacCready settings when the height limit is not reached at B (Fig. 20, cases (a), (b) and (c)) are given by

$$(4.14a) \quad z_{AB \text{ opt}} = z_C \quad z_{BC \text{ opt}} = z_C \quad (z_{AB} < z_C)$$

and where it is reached at B (Fig. 20, case (e)) by

$$(4.14b) \quad z_{AB \text{ opt}} > z_C \quad z_{BC \text{ opt}} = z_C \quad (z_{AB} < z_C)$$

In the favorable but infrequent situation where z_C is surpassed by z_{AB} the optimal MacCready ring settings when the height limit is not reached at B (Fig. 20, case (d)) are given by

$$(4.14c) \quad z_{AB \text{ opt}} = z_{AB} \quad z_{BC \text{ opt}} = z_C \quad (z_{AB} > z_C)$$

while when it is reached at B (Fig. 20, case (e)) they are given by

$$(4.14d) \quad z_{AB \text{ opt}} > z_{AB} \quad z_{BC \text{ opt}} = z_C \quad (z_{AB} > z_C)$$

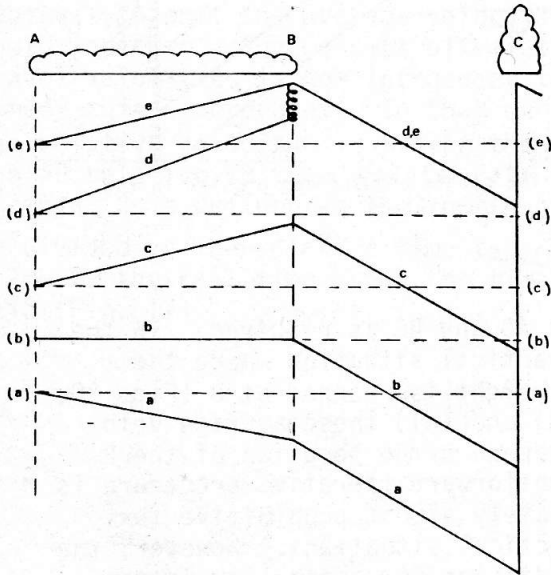

Fig. 20: Different optimal paths for different vertical atmospheric velocities under a single cloudstreet

In the former of these latter two cases the optimal strategy is to use some extra circling at B to reach the height limit under the cloudstreet before leaving. Thus, the height limit is reached at B in all cases except those of relation (4.14a).

Given the conditions of optimality of a trajectory in the vertical plane, differentiation shows that, for simultaneous optimality in the

horizontal plane, the same simple geometric condition on the fly-off angle (relation (4.9)) holds, and the relative travel velocities v_{BC}/C and v_{AB}/C are given as before by relation (4.13) and (4.12) respectively.

When $u_{BC} = 0$ it is simple to show that v_{BC}/C is just equal to the MacCready travel velocity corresponding to z_C

$$(4.15) \quad v_{BC}/C = \frac{z_C}{z_C - w_p(v_{MCR}(z_C))} v_{MCR}(z_C) = v_{MCR r}(z_C)$$

Unfortunately, a similar simple relation cannot be given for v_{AB}/C . Only if the height limit under the cloudstreet is not reached at B can a general expression be given (Fig. 21).

$$(4.16) \quad v_{AB}/C =$$

$$\frac{z_C}{z_C - w_p(v_{MCR}(z_C - u_{AB})) + u_{AB}} v_{MCR}(z_C - u_{AB})$$

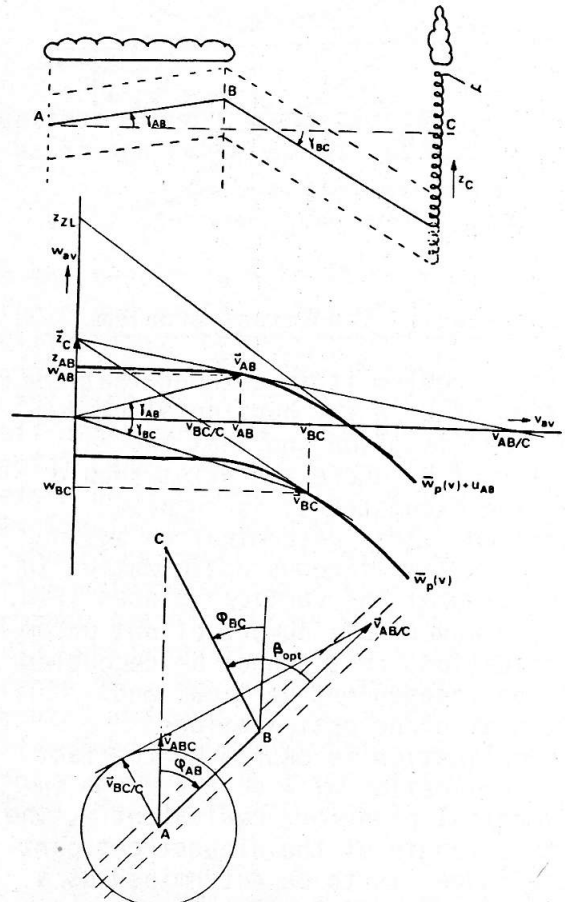

Fig. 21: The graphical determination of the optimal fly-off angle β_{opt} in case of a single cloudstreet and $z_C \geq z_{AB}$ (cf. Fig. 20a,b,c)

In all other cases $v_{AB,av}$ and $w_{AB,av}$, which are the main building stones for the relative travel velocity $v_{AB/C}$ (cf. (4.12)) depend on the exact location of B and this depends in turn on $v_{AB/C}$. An iterative procedure will therefore be called for to determine the proper location of B and possibly the proper value of the MacCready ring setting $z_{AB, opt}$ that together satisfy the optimality conditions in both vertical and horizontal planes. An interesting result in this context is given in Fig. 22.

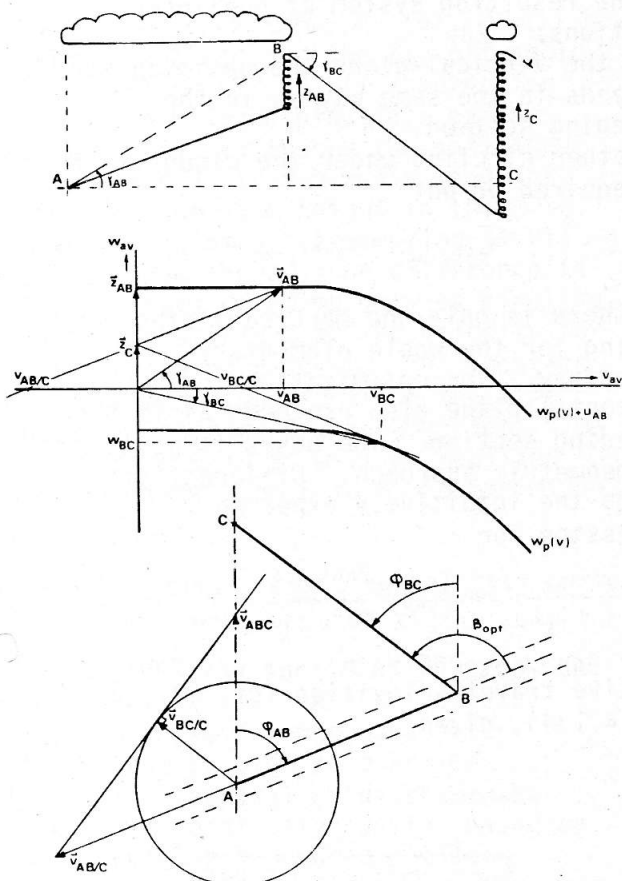

Fig. 22: The graphical determination of the optimal fly-off angle β in case of a single cloudstreet and $z_{AB} \geq z_C$ (cf. Fig. 20d)

It will be evident that it will be practically impossible to determine an exact optimal strategy in most practical situations. Nevertheless, the theory provides a way to determine upper and lower bounds for the parameters that

determine the optimal strategy in most cases. To be precise, where the absolute rate of climb under the cloudstreet is less than the expected absolute rate of climb under the cloudstreet, it is possible to determine the optimal values for the MacCready ring setting and the fly-off angle for the two extreme situations which correspond to values of the height limitation of respectively 0 and infinity (Fig. 23, cases I and III). The values thus obtained will serve as a good guide for the choice of the proper values in the actual situation (Fig. 23, case II).

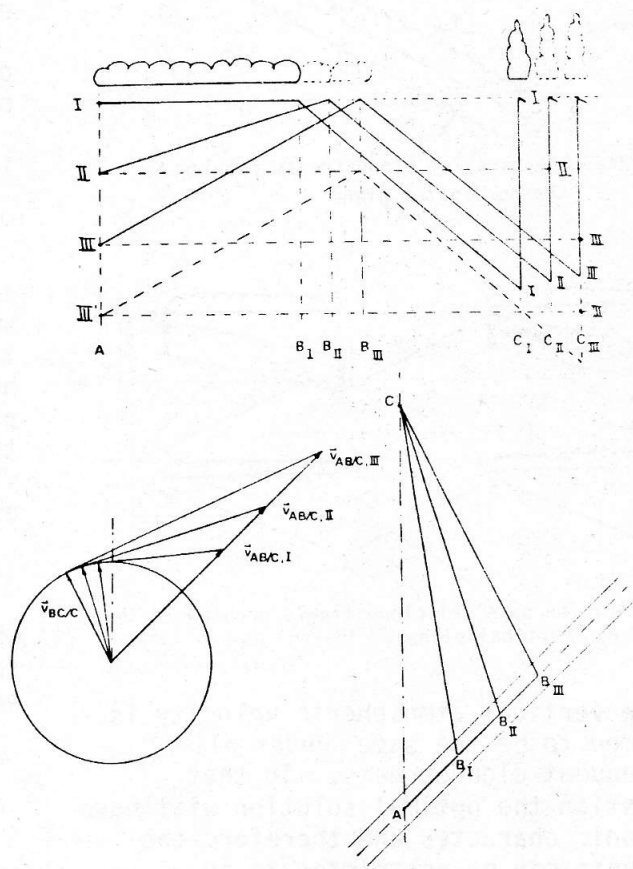

Fig. 23: Different optimal flight paths in the vertical and the horizontal plane for the same vertical atmospheric velocity but different initial heights (cf. Fig. 20e)

4.4 The parallel cloudstreets problem

In the case of parallel cloudstreets the sailplane should always climb to the

maximum height at B (Fig. 24). In fact, all climbing takes place under the cloudstreet. As in the preceding section simple decoupling of the optimizations in the horizontal and the vertical will only be possible in certain situations.

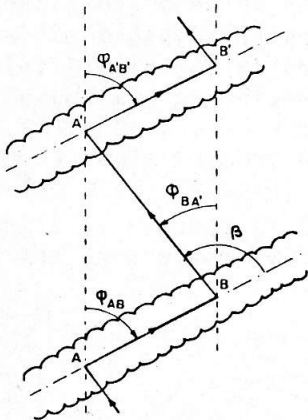

Fig. 24a: The parallel cloudstreets problem in the horizontal plane

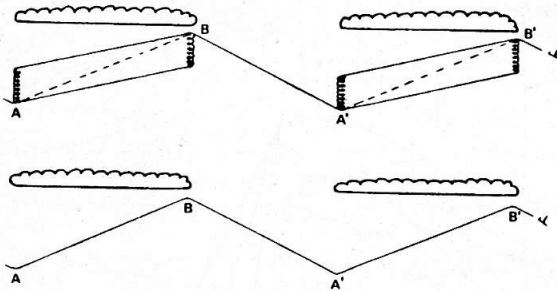

Fig. 24b: The parallel cloudstreets problem in the vertical plane

The vertical atmospheric velocity is assumed to be the same under all subsequent cloudstreets. In that situation the optimal solution will have periodic character and therefore the analysis can be restricted to an elementary trajectory consisting either of a climb under the cloudstreet followed by a descent to the next cloudstreet or of such a descent followed by such a climb. We select the latter case since the height of the initial and final point is uniquely defined and since, as such, the problem formulation fits in better with that in the preceding section. The sailplane

starts at height h_B at B, descends to $h=0$ at A' and thereafter climbs again to h_B at B'. The problem to be solved now is to find the two cruise velocities $v_{BA',cr}$ and $v_{A'B',cr}$ the height h_B and the fly-off angle β such that the time necessary to fly along BA'B' is minimized. It should be noted that the absolute rates of climb at B and along A'B' are the same, indicated as z_{AB} .

The solution procedure is as in the preceding section. First the necessary conditions for optimality are to be established; thereafter an iterative procedure is to be used for the solution of the resulting system of nonlinear equations:

In the vertical plane the optimization proceeds in the same way as in the preceding section.

Whether circling under the cloudstreet is required or not

$$(4.17) \quad z_{BA',opt} = z_{A'B',opt} = z_{opt}$$

and there is only one MacCready ring setting for the whole elementary trajectory. The optimization in the horizontal plane also proceeds as in the preceding section. The basis is again the geometric approach. Differentiation yields the intuitively expected expression for

$$(4.18) \quad \cos \beta_{opt} = \frac{v_{AB',opt}}{v_{A'B',opt}}$$

where $v_{AB',opt}$ and $v_{A'B',opt}$ are the relative travel velocities (cf. (4.12) and (4.13)), given

$$(4.19) \quad v_{BA',opt} = \frac{z_{opt}}{z_{opt} - (w_p(v_{BA',cr}) + u_{BA'})} v_{BA',cr}$$

and

$$(4.20) \quad v_{A'B',opt} = \frac{z_{opt}}{z_{opt} - (w_p(v_{A'B',cr}) + u_{A'B'})} v_{A'B',cr}$$

They are defined in this way relative to an absolute rate of climb that is nowhere present in reality but which follows from the solution of the opti-

mization problem in the vertical plane. It is of interest to note that the presence of a thermal with an absolute rate of climb equal to z_{opt} at B' or B would not change the optimal solution.

If circling is required to reach the maximum height at B', the optimal MacCready ring setting will be equal to the absolute rate of climb under the cloudstreet. If one assumes this to be equal to the sum of the vertical atmospheric velocity and the minimum velocity of descent of the sailplane, i.e.,

$$(4.21) \quad z_{opt} = w_{p,max} + u_{A'B'} = z_{AB}$$

then relative velocity $v_{A'B'}/opt$ will be infinitely large and the fly-off angle β_{opt} will be 90° . This interesting result can be made plausible by the argument that in theory the sailplane could reach B' from a whole range of points at the same height in the neighborhood of A': assumption (4.21) implies that there is no difference in absolute rate of climb between circling and flying straight at the velocity for minimum rate of descent. The location of A' being unimportant for the time spent in reaching B', the shortest time to fly from B to B' will be realized when the time from B to A' is minimized (Fig. 25).

4.5 The optimal resulting velocity curve or orv-curve and the zigzag computer

The necessity of an iterative procedure makes it very difficult to compute z_{opt} and β_{opt} for the parallel cloudstreet problem in practice. Instead a graphical solution may be determined relatively easily, based on the use of a precomputed optimal-resulting-velocity curve or orv-curve. This curve is defined as the polar graph of the endpoints of the optimal resulting velocity vectors (Fig. 26) that correspond to values of the cloudstreet direction angle ϕ_{AB} between 0° and 90° . Its usefulness for practical application follows from special properties of the tangent to the curve at any point, namely:

- (i) the normal through the origin

perpendicular to the tangent line makes an angle with the horizontal axis equal to β_{opt} corresponding to ϕ_{AB} .

(ii) the length of the normal in (i) represents in the appropriate scale the resulting (or MacCready) velocity that corresponds to a MacCready ring setting z_{opt} .

(iii) the tangent line cuts the horizontal axis at a point representing the relative travel velocity $v_{A'B'}/opt$.

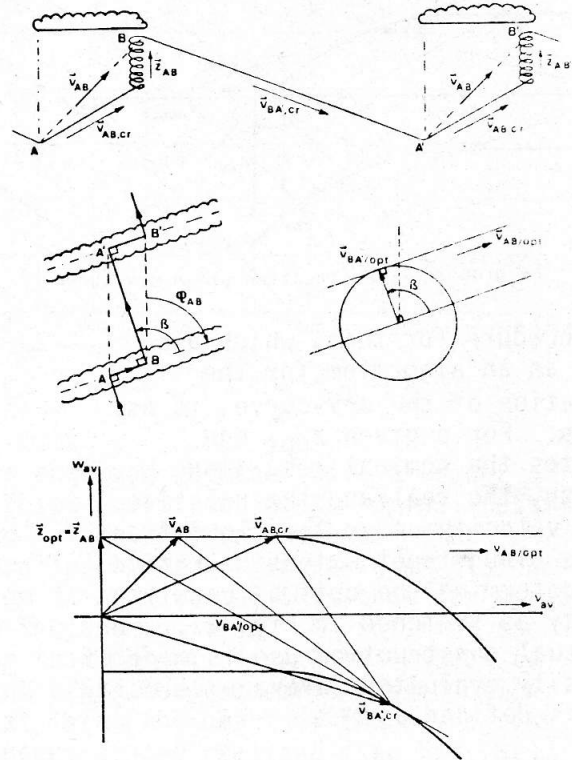

Fig. 25: Optimal zigzag trajectory in case of a large cloudstreet angle

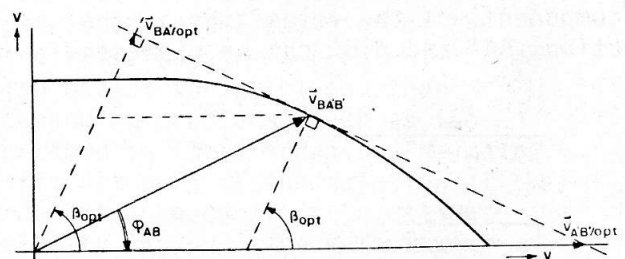

Fig. 26: The optimal-resulting-velocity or orv-curve for parallel cloudstreets

The basis of these properties, which can be proved analytically, is the

geometric construction of the optimal resulting velocity for a given optimal MacCready ring setting (see Fig. 27).

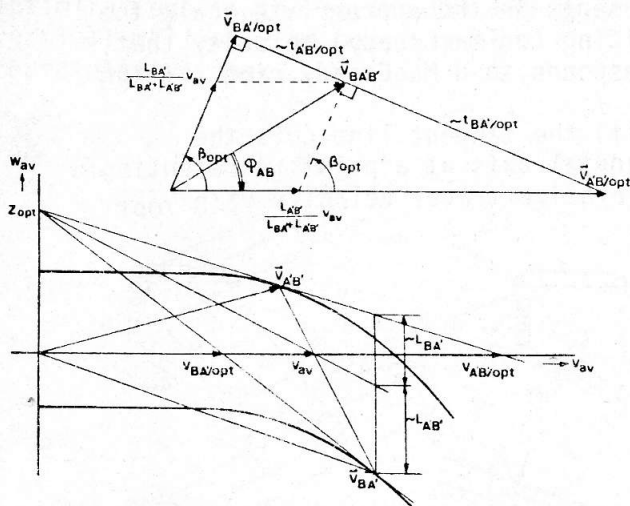

Fig. 27: The graphical construction of an orv-curve

The procedure for this, which also serves as an algorithm for the computation of the orv-curve, is as follows: For a given z_{opt} one evaluates the nominal resulting velocity, the real and the relative travel velocity under the cloudstreet and the cloudstreet extension ration. These determine the optimal resulting velocity as sketched in Fig. 27. For the actual construction use is made of the easily evaluated "average velocity" which is defined as

$$(4.22) \quad v_{av} = \frac{t_{BA'/opt} \cdot v_{BA'/opt} + t_{A'B'/opt} \cdot v_{A'B'/opt}}{t_{BA'/opt} + t_{A'B'/opt}}$$

The components of the velocities in the directions BA' and $A'B'$ can be expressed as

$$(4.23) \quad \frac{t_{BA'/opt}}{t_{BA'/opt} + t_{A'B'/opt}} v_{BA'/opt} = \frac{L_{BA'}}{L_{BA'} + L_{A'B'}} v_{av}$$

and

$$(4.24) \quad \frac{t_{A'B'/opt}}{t_{BA'/opt} + t_{A'B'/opt}} v_{A'B'/opt} = \frac{L_{A'B'}}{L_{BA'} + L_{A'B'}} v_{av}$$

The angle ϕ_{AB} and the optimal resulting velocity $v_{AB/opt}$ can therefore be constructed. An example of orv-curves is given in Fig. 28.

In the neighborhood of the vertical axis the orv-curve reduces to a straight line parallel to the horizontal axis the length of which is equal to the nominal resulting velocity corresponding to the best absolute rate of climb. For all points on the straight line the optimal strategy includes some circling.

The velocity at which the orv-curve cuts the horizontal axis is that at which the sailplane just flies horizontally under the cloudstreet. The appropriate MacCready ring setting that will generate this velocity may be found by drawing a tangent line at that point and by determining the distance from the origin to that tangent line and evaluating the MacCready ring setting to which corresponds the same nominal resulting velocity.

The use of the orv-curve for the (graphical) solution of the parallel cloudstreet problem will be self-evident. Given the appropriate orv-curve and the cloudstreet angle, the optimal resulting velocity can be constructed immediately (Fig. 29). z_{opt}

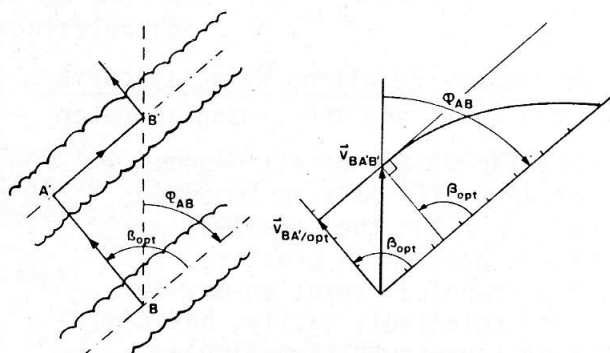

Fig. 29: Example of the use of the orv-curve for the determination of the optimal fly-off angle and the optimal MacCready ring setting in case of parallel cloudstreets

and β_{opt} follow directly after the construction of the tangent line and the normal to it from the origin. The use of the orv-curve has the added advantage that a wind from an arbitrary direction can be easily handled (Fig. 30).

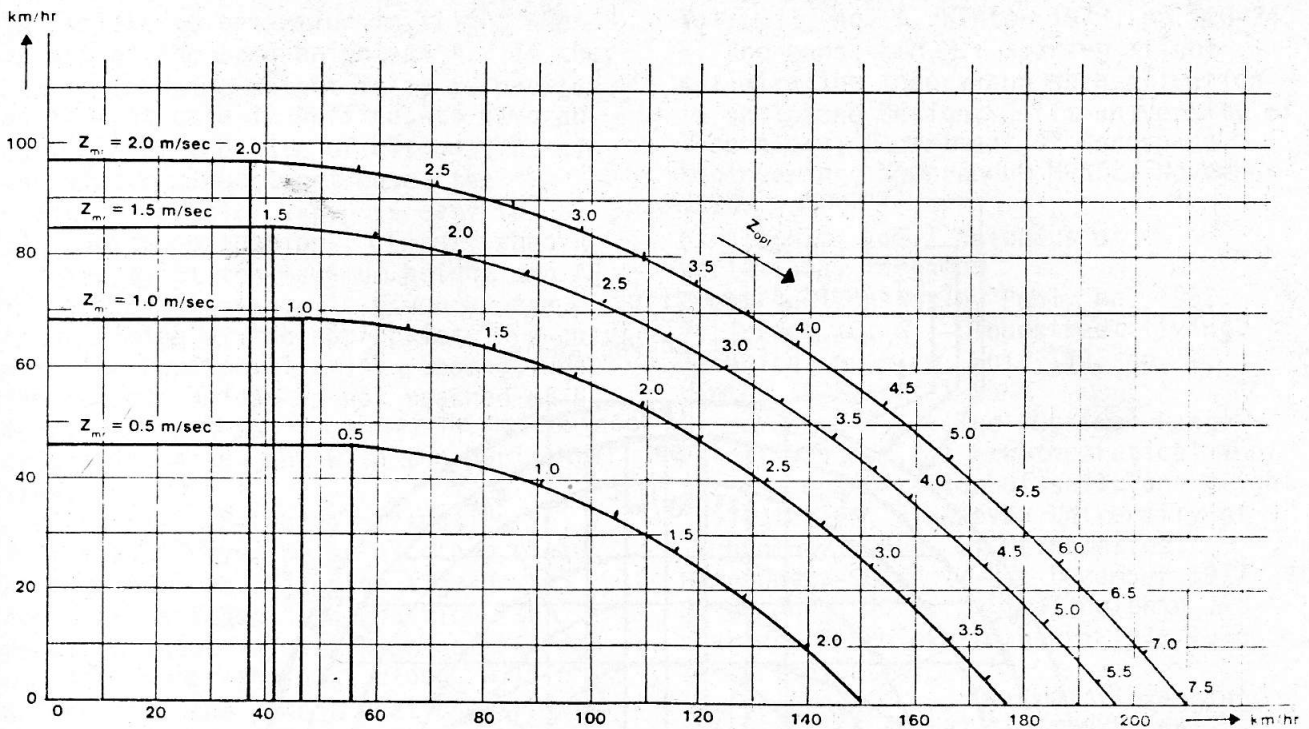

Fig. 28: Optimal-velocity or orv-curves for an LS-3 sailplane with a wing loading of 45 kg/m²

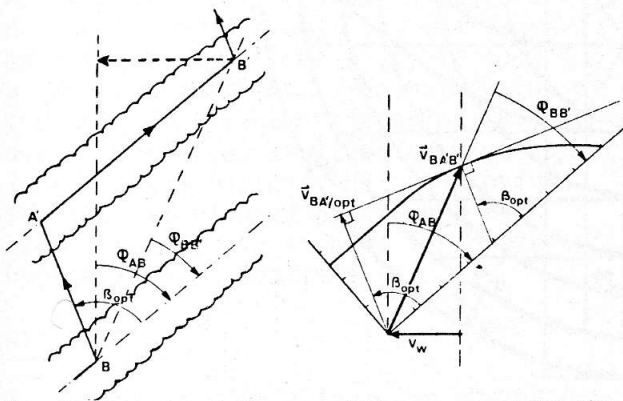

Fig. 30: Example of the use of the orv-curve for the determination of the optimal fly-off angle and the optimal MacCready ring setting in case of parallel cloudstreets and wind from an arbitrary direction

For use in flight a special device was developed to perform the graphical solution. This device, named the "zigzag computer" comprises (Fig. 31) two circular transparent discs, one nontransparent disc with a compass rose engraved on it and a rectangular piece, all of which can freely rotate with respect to each other. On one transparent disc two sets of orv-curves for different sailplane configurations

are engraved together with a number of circles corresponding to nominal resulting velocities; on the other disc parallel lines are engraved at distances from the horizontal axis that correspond to those velocities. By rotating the two transparent discs with respect to each other the geometric construction that is at the heart of the orv-curve concept can be realized (see Fig. 32). The rectangular piece provides the descent course direction, the compass rose disc the actual course directions in flight.

The use of the zigzag computer is not restricted to the solution of the parallel cloudstreet problem. It may also assist the pilot in other zigzagging problems, such as those sketched in 13 (a and b). The most difficult part of the solution of these problems in general is to estimate the velocity $v_{AB/C}$. (The velocity $v_{BC/C}$ is equal to $v_{MCr,r}(z_c)$ and circles with radii corresponding to nominal resulting velocities for different rates of climb are drawn on one of the discs.) In the case of the single cloud problem the $v_{AB/C}$ is practically

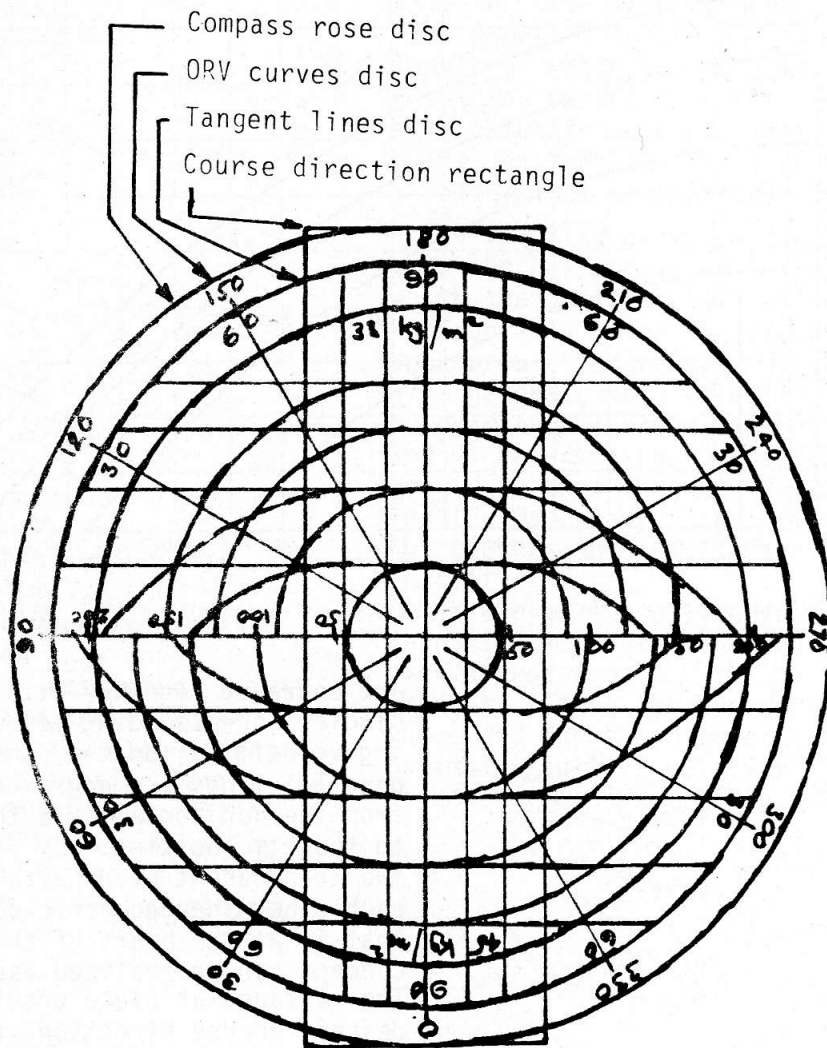

Fig. 31: Zigzag computer - diagrammatic. Actual instrument would have 2 to 3 times as many graduations.

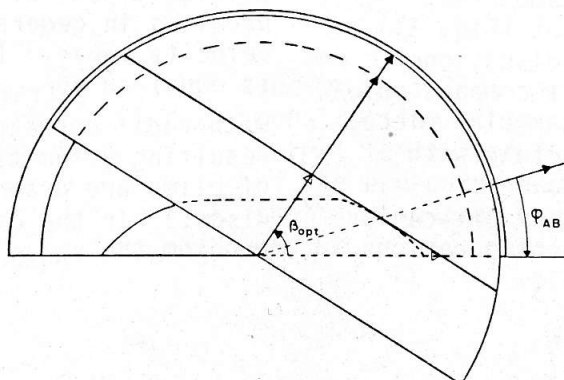

Fig. 32: Principle of operation of the zigzag computer

impossible to determine in flight when B is not at the same height as A. If they are at the same height it is no problem, as in that case it suffices to have an estimate of the rate of climb at B. In the single cloudstreet case, the relative velocity $v_{AB/C}$ is easy to find in two situations. First, when A is already at the maximum height and AB is horizontal, $v_{AB/C}$ is given by the intersection of the appropriate orv-curve with the horizontal axis. Second, when the maximum height is not reached at B. (provided $z_C > z_B$) $v_{AB/C}$ may be determined by drawing a tangent with the horizontal axis.

Of course, the actual situation in flight will never be so nice and clean as the model on which the zigzag computer is based. In addition, the required input values, such as the rate of climb under the next cloud, will only be known at the moment that one arrives there. Therefore, the solutions provided by the zigzag computer will never be exactly optimal in practice. However, the real optimal solutions will not be very different, and with some experience it will be possible to get good approximations. The main value of the device lies therefore not in the direct practical application, but rather in the extra insight that it provides for the experienced pilot when he exercises with it at home for different hypothetical situations.

REFERENCES

1. Ahrens, K.: Die allgemeine Lösung des Problems: Optimale Nutzung kursabweichenden Aufwindstrassen, *Aerokurier*, 8/1976, pp. 524-527.
2. Ahrens, K & Sand, P.: Optimales Ausnutzen von kursabweichenden Aufwindstrassen in Windrichtung, *Aerokurier*, 8/1974, pp. 600-601.
3. Antweiler, P.: Zur Theorie des Delphinstils, *Luftsport*, nr. G, Juni 1972, p. 13.
4. Arho R.: Optimal dolphin soaring as a variational problem, *Technical Soaring*, Vol. III, no. 1, Winter 1973, pp. 20-24.
5. Boermans, L.M.M.: Soaring flight optimization theory and an application in sailplane design, Delft university of Technology, Department of Aerospace Engineering, Memorandum M-352, November 1979.
6. Elsgolc, L.E.: *Calculus of variations*, Pergamon Press/Addison-Wesley Publ. Co. 1962.
7. Irving, F. G.: *Cloudstreet flying*, *Technical Soaring*, Vol. III, no. 1, Winter 1973, pp. 1-8.
8. de Jong, J.L.: The "Optimal Range Velocity polar," a new theoretical tool for the optimization of sailplane flight trajectories, Eindhoven University of Technology, Dept. of Mathematics, Memorandum-COSOR 77-28, December 1977.
9. de Jong, J.L.: Optimal dolphin soaring, *Thermiek*, Januari 1978/1, pp. 22-29 (in Dutch).
10. de Jong, J.L.: Optimal zigzagging, *Thermiek* (in parts) I: 1979/1, pp. 22-27, II: 1979/2, pp. 48-54, III: 1979/4, pp. 140-147 and IV: 1980/2, pp. 58-65 (in Dutch).
11. Kauer, E & Junginger, H.G. & Ahrens, K.: Segelflug im Delphinstil, *Aerokurier* 9/1973, pp. 618-660, 10/1973, p. 741.
12. Megzger, D.E. & Hedrick, J.K.: Optimal flight paths for soaring flight *AIAA J. of Aircraft*, 12, nr. 1, November 1975, pp. 876-871.
13. Meyer, R.: Dolphin style gliding, *Technical Soaring*, Vol. V, no. 1, pp. 1-9.
14. Petruschke, W.: Zur Theorie des zeitoptimalen Streckensegelfluges, Dissertation, Technische Universität München, Juni 1977.
15. Pirker, H.: Über die Reisegeschwindigkeit von Segelflugzeugen, *Flugsportzeitung* 11/1974, pp. 11-16, 1/1975, pp. 17-25.
16. Reichmann, H.: *Strecken Segelflug*, Motorbuch Verlag, Stuttgart 1975.
17. Weinholtz, F.W.: *Grundtheorie des modernen Strecken Segelfluges*, 5^e Auflage, Verlage für Luftsport und Luftfahrt Grawe, Bochum 1975.